

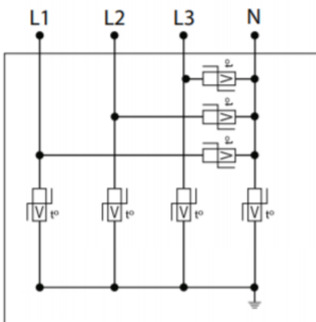

- ✦ Multi-TMOV Technology
- ✦ UL1449 Type 1 LISTED
- ✦ 105-220kA Surge Current Rating
- ✦ Visual fault indicator, audible alarm and remote contacts
- ✦ 10-Year warranty



Electrical Characteristics		
POWER SPD TYPE		UL1449 TYPE 1 LISTED
VOLTS	(V)	277/480
AC/DC/DC PV/RF		AC
PHASE	(PH)	3Y
AMPS	(A)	N/A
AMBIENT MIN	(C)	-35
AMBIENT MAX	(C)	+85
MODES		L-L, L-N, L-G, N-G
VPR	(V)	1800/1000/1200/1000
MCOV	(V)	640/320/320/320
IN	(kA)	20
15 impulses 8/20µs		
IMAX	(kA)	220
8/20µs		
Mechanical Characteristics		
Weight		5 kg
TECHNOLOGY		Multi-TMOV
NETWORK CONFIGURATION		3PH, 4W+G, Wye
CONNECTION METHOD		36" #10 AWG LEADS
MOUNTING		FLANGE MOUNT
MATERIAL		Steel
NEMA RATING (IP RATING)		IP65
FAIL-SAFE BEHAVIOR		Yes, no upstream over current protection required
REAL-TIME DIAGNOSTICS		% of protection present LED, audible alarm and remote contacts. Optional surge counter.
DIMENSIONS		See diagram
WEIGHT		6 lbs
Standards		
Certification		UL Listed
UL STANDARD		UL1449 5th Edition
UL CATEGORY		VZCA, VZCA7
UL FILE NUMBER		E326289
STANDARDS		UL96A, ANSI C62.41/45, NOM-003-SCFI-2014, NOM-001-SCFI-1993, IEC61643-11
ENVIRONMENTAL STANDARDS		ROHS
Part number		
890130		