

DIS878 & 978 STRAIN GAUGE (BRIDGE) INPUT PROCESS INDICATORS



DESCRIPTION

The DIS878 (3½ DIGIT) and DIS978 (4½ digit) Process Indicators provide a red LED display, optional isolated DC output voltage or current proportional to the output of a strain gauge bridge and optional single or dual alarm setpoints. The units include filtering and conditioning to reduce susceptibility to transients and noisy operations. The digital display utilizes an auto-zero dual-slope integrating A/D converter for accuracy and stability.

All DIS instruments are gasketed and, when properly installed, are NEMA-4X waterproof and corrosion resistant. Controls are accessible by removing a gasketed front access panel. The display's controls are wide ranging so that it can be calibrated to display engineering units. Decimal point selection is made with a switch, also accessible from the front. A complete set of engineering unit labels is sent with each DIS. Once the display has been adjusted to read the correct engineering units, the alarm setpoints can be adjusted without test equipment and without disturbing the output voltage or current.

Each setpoint has an LED to indicate alarm status. The alarms have adjustable deadbands. Terminations are made to a screw terminal on the rear of the case.

INSTALLATION

DIS Series instruments are designed to be mounted from the front of a panel through a standard horizontal 1/8 DIN cutout. Two mounting cams secure the DIS to the front panel. Figure 1 shows the case and panel cutout dimensions.

To install the DIS in the cutout, turn the two cam-lock screws (on the front panel - see Figure 1) counterclockwise until the cams move far enough toward the rear to clear the panel thickness. Insert the case through the panel cutout and turn the cam-lock screws clockwise until both are tight.

GROUNDING

All DIS models should be properly grounded for safety and for minimum noise pickup. Connect the GROUND lug on the instrument's rear panel to earth ground.

FIGURE 1-
DIS Case and Panel Dimensions

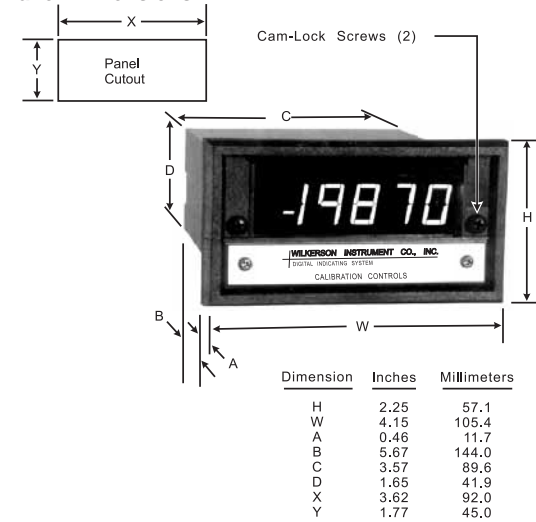

CONTROLS

All user-adjustable controls are located behind the front panel. To gain access, simply loosen the two screws and remove the gasketed CALIBRATION CONTROLS panel. Front-panel controls include:

- Display: zero, span and decimal point.
- Alarm setpoint calibration switch.
- Alarms (optional): setpoint and deadband.
- Transmitter output (optional): zero and span.

Each optional alarm board also contains a zero and span control. These are not normally adjusted by the user, and require removal of the instrument assembly from its housing.

CALIBRATION

All DIS Series instruments are precisely calibrated at the factory. In normal use only the alarm setpoint and deadband, and possibly the display range, need to be adjusted. However, complete user recalibration is possible. If you need to recalibrate, proceed as follows:

Input Connection

Connect a precision DC voltage or current source to the INPUT + and - terminals. For low level inputs, an input cable shield may be connected to the SH terminal.

FIGURE 2 - Calibration Control Locations

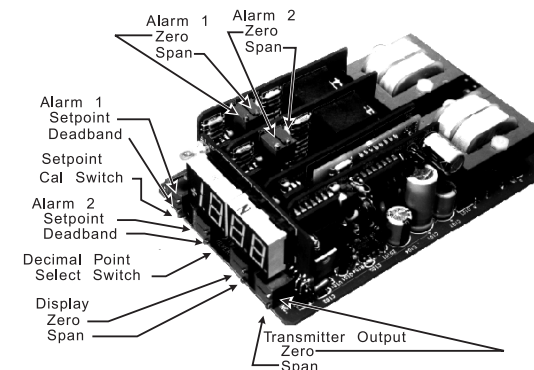

DISPLAY CALIBRATION

(4½ Digit Only) Set the display OFFSET jumper to the proper position, as shown in Figure 3.

To calibrate the display, rotate the DECIMAL POINT select switch until the desired decimal point illuminates. Set the input source for the low end value and adjust the display zero (DISPLAY Z) control for the desired reading on the display. Advance the input source to the full scale value and adjust the display span (DISPLAY S) control for the desired reading. For maximum accuracy, repeat the procedure once or twice as the controls may interact slightly.

Figure 3. Display Zero Offset Jumper (4½ Digit Only).

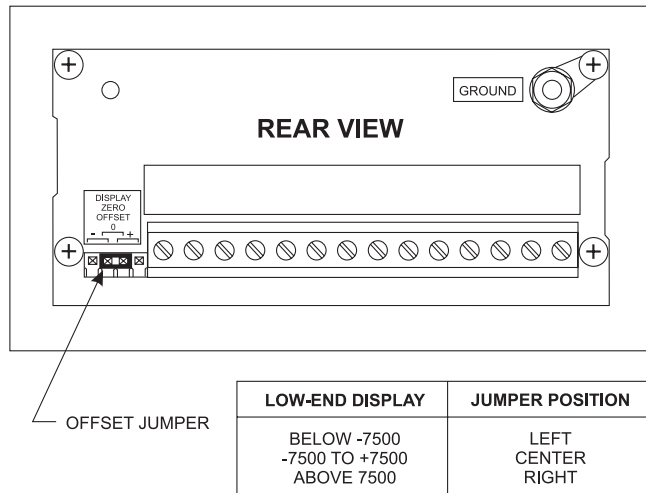

Alarm Setpoint and Deadband Calibration

The SP CAL switch is a three-position toggle which allows the instrument to display each alarm's setpoint. No test equipment is required to set the alarms with a properly calibrated display. To set the alarm #1 setpoint, put the toggle in the up (1) position and adjust the AL1 SP control until the display indicates the desired setpoint. Put the toggle down (2) to similarly adjust AL2 SP. Returning the toggle to its center position provides normal operation.

Turn each alarm deadband (DB) control fully counterclockwise for minimum deadband (about 0.25%) or fully clockwise (25 turns) for maximum deadband (about 100%). The deadband is approximately symmetrical about the setpoint. If precise deadband settings are needed, connect a calibration source to the input as described earlier. Vary the input up and down and adjust the DB controls until the desired amount of deadband is achieved.

Alarm Zero and Span

The alarm zero and span adjustments calibrate the alarm circuitry so that the display properly indicates the setpoint. These adjustments are factory set and do not normally need to be changed unless the instrument has been repaired. If you need to recalibrate, remove the instrument from its housing (refer to the "Adding Options" section) and connect a calibration source to the input as described earlier. Turn each alarm's deadband (DB) control fully counterclockwise for minimum deadband.

The zero and span controls are located on the top edge of each board. ZERO is nearest the front, SPAN nearest the back.

Each alarm has an LED to the left of the digits that lights when the alarm trips and goes out when the alarm resets. Alarm #1 is the upper LED and alarm #2 is the lower LED.

With the SP CAL switch in its center position, set the input to the low end value and observe the reading on the display. Put the switch in the up position for alarm #1 or down for alarm #2 and adjust the alarm's setpoint (SP) until the DIS again displays the low end value. Adjust the alarm's ZERO control until its LED lights.

Return the SP CAL switch to its center position, increase the input to full scale and observe the display reading. Put the switch back in the up (alarm #1) or down (alarm #2) position and adjust the alarm's SP for full scale display. Adjust the alarm's SPAN control until its LED lights.

Repeat these adjustments once or twice, as the controls may interact slightly, then return the SP CAL switch to its center position. Set the alarm setpoints and deadbands as described above.

Transmitter Output Calibration

Set the input to the low end value and adjust the transmitter zero (TRANSMITTER Z) control for the desired output. Increase the input to the full scale value and adjust the transmitter span (TRANSMITTER S) control for the desired value. For maximum accuracy, repeat the procedure once or twice as the controls may interact slightly.

RELAY CONTACT PROTECTION

When inductive loads such as motors, relays or transformers are switched, voltage transients may be generated which exceed the ratings of the relay contacts. The resulting arcing can quickly destroy the contacts. (Refer to the SPECIFICATIONS below for the relay contact ratings.) Surge suppression is required across inductive loads to guard against premature relay failure. Figure 4 illustrates diode surge suppression for a DC load. The diode's operating (peak inverse) voltage should exceed the load's supply voltage by at least 50% and should have a current rating of at least one ampere.

Figure 5 shows surge suppression for an AC load, using an MOV (Metal Oxide Varistor) and a capacitor. The breakdown voltage ratings of both the MOV and the capacitor must exceed the peak AC voltage.

With normal sine-wave power, PEAK = 1.414 x RMS voltage. For 115V AC power a 200 volt peak rating is recommended.

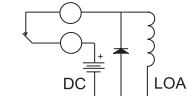

FIGURE 4
Surge Suppression
Inductive DC Load

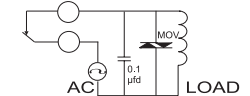

FIGURE 5
Surge Suppression
Inductive AC Load

SPECIFICATIONS

INPUT SPAN

0.5 mV/V to 1 V/V

INPUT IMPEDANCE

200 kilohms

EXCITATION

fixed 10 V, 40 mA max load

OUTPUT RANGE

Voltage

select any range between ± 10 V,
10 mA max load (min span 0.2 V)

Current

select any range from 0 to 20 mA max,
24 V compliance* (min span 1 mA)

SETPOINT

each alarm 0 to 100% of span

DEADBAND

0.25% to 100% of span

RESPONSE TIME

≥ 500 ms

ACCURACY

$\pm 0.1\%$ of span

LINEARITY

Display
 $\pm 0.15\%$ of span

Output
 $\pm 0.025\%$ of span

OUTPUT RIPPLE

(peak-to-peak)

$< 0.1\%$ of span

COMMON MODE REJECTION

120 dB, DC to 60 Hz

ISOLATION

Output/Input
>500 M ohms

Breakdown Voltage
>600 VAC rms

DISPLAY (878)

Digit Size

.56" LED, 3½ digits, ± 1999

Decimal Point

$\pm 1.9.9.9$

Control Range Zero

± 1999

Span

min span 10/max span 2000

DISPLAY (978)

Digit Size

.56" LED, 4½ digits, ± 19999

Decimal Point

$\pm 1.9.9.9.9$

Control Range Zero

± 19999

Span

min span 100/max span 20000

DISPLAY

Update

3/sec

RELAY CONTACTS

(SPDT)

Resistive Load:

5A max, 150W max,
240 VAC max,
30 VDC max

Inductive Load:

1/8HP max at 120/240 VAC

OPERATING TEMPERATURE

14°F to 140°F/-10°C to 60°C

TEMPERATURE STABILITY

$\pm 0.02\%$ of span or $0.025^\circ\text{C}/^\circ\text{C}$,
whichever is greater

POWER

115 VAC $\pm 10\%$,
50 or 60 Hz
230 VAC $\pm 10\%$,
50 or 60 Hz
(4 W max)

* Compliance: The sum of all voltage drops in the output loop cannot exceed 24 V at rated current (1200 ohms @ 20mA).

WARRANTY

The DIS Series of products carry a limited warranty of 5 + 5 years. In the event of a failure due to defective material or workmanship, during the 5 year period, the unit will be repaired or replaced at no charge. For a period of 5 years after the initial 5 year warranty, the unit will be repaired, if possible, for a cost of 10% of the original purchase price.

Relays are not covered by the warranty.

DIS SERIES OPTIONS

In addition to the display, alarm and transmitter choices described above, the following options are available:

H/L H = High Alarm. Alarm occurs on an increasing signal.
L = Low Alarm. Alarm occurs on a decreasing signal.
Specify H or L for single alarms. (H supplied if not specified.)
Specify H/H, H/L, or L/L for dual alarms. (H/L supplied if not specified.)

R Reverse Sense. Normal condition for the relays is energized. They de-energize for alarm conditions or loss of power to provide fail-safe relay operation. Option R reverses this logic

RD Reverse-acting display. The display reading decreases as the input increases.

RT Reverse-acting transmitter. The transmitter output decreases as the input increases.

U All circuit boards conformal coated for protection against moisture.

ADDING OPTIONS

DIS Series II alarm and transmitter output options consist of plug-in circuit cards, which may be added by the user. To do so it is necessary to unscrew and remove the back panel, slide out the internal assembly, plug in the appropriate cards and calibrate. It is not necessary to remove the housing from its installation.

CAUTION: The DIS circuitry is precise, sensitive and closely spaced. Circuit board contamination can lead to errors and instability, especially at high humidities. Handle all circuit boards by their edges only, or wear clean gloves, to avoid contamination.

Begin by disconnecting the wires from the rear terminals. If you wish to remove the instrument from its installation, turn the two cam-lock screws (Fig. 1) counterclockwise and slide the instrument out of its mounting.

Unscrew the four screws which hold the rear panel in place. Remove the panel, and slide the internal assembly out of the case.

Figure 6 shows the internal assembly. To install options you must first remove the display assembly as shown. Pull it straight up.

FIGURE 6-ADDING OPTIONS

The display assembly must be unplugged to allow cards to be installed.

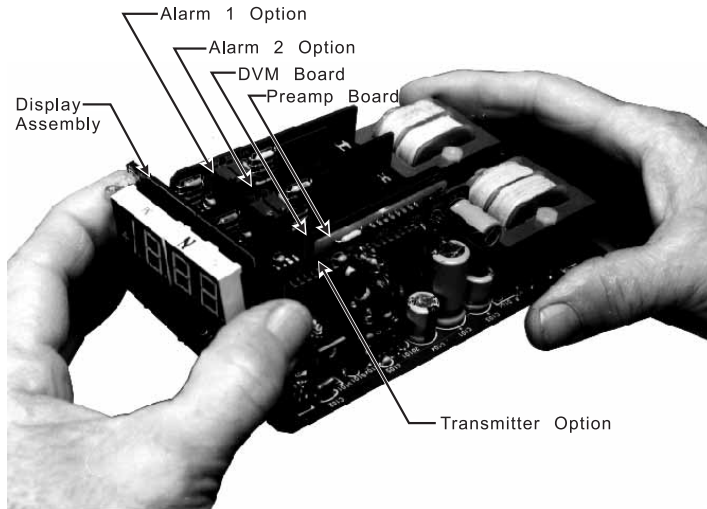

Figure 6 shows the internal assembly. To install options you must first remove the display assembly as shown. To remove it pull straight up.

To install or remove an option card, simply plug or unplug it from the appropriate position per Fig. 6. ENSURE ALL CONNECTOR PINS ARE ENGAGED.]

Reinstall the display assembly. ENSURE ALL GOLD PINS ARE ENGAGED.

Calibrate the new options as described earlier under **CALIBRATION**. It should not be necessary to recalibrate the display itself, or any options which were previously installed and calibrated. The instrument may be calibrated while out of its case.

(CAUTION: Avoid exposed PC traces and wires, which may carry hazardous voltages.)

For best accuracy (and safety), however, reinstall the instrument in its case and allow 15 minutes warmup before calibrating.

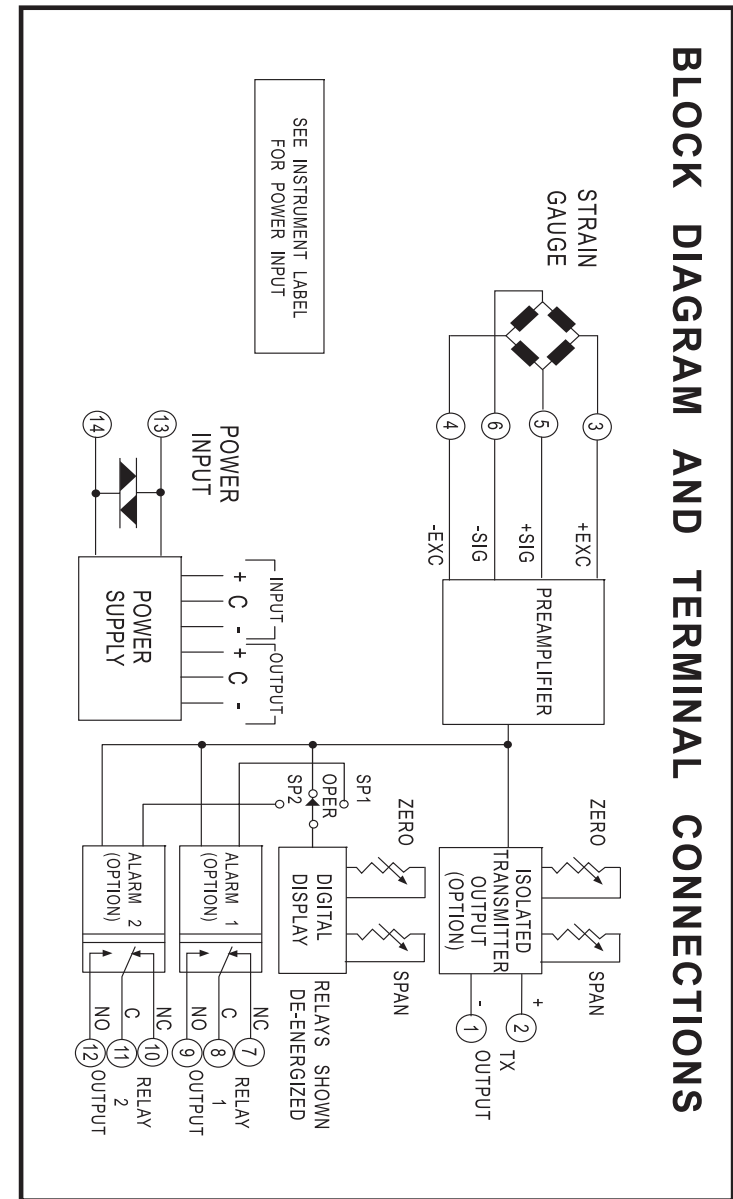

Specifications are subject to change without notice. ©2007 Wilkerson Instrument Co., Inc. DWG#W101987 4/07



2915 Parkway Street
Lakeland, FL 33811-1391 · USA

800-234-1343

Tel: 863-647-2000 · Fax: 863-644-5318
www.wici.com · E-mail: sales@wici.com